

Tile Tech IPÊ-Tile™

Paving America one step at a time!

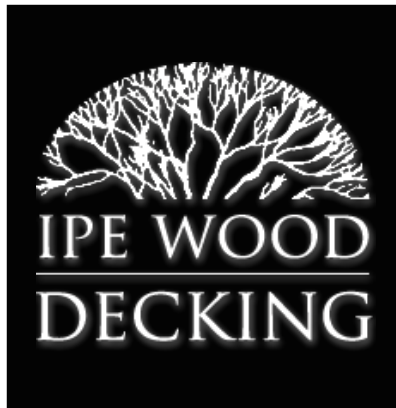

MANUFACTURER OF IPÊ WOOD TILES & ADJUSTABLE PEDESTAL SYSTEMS

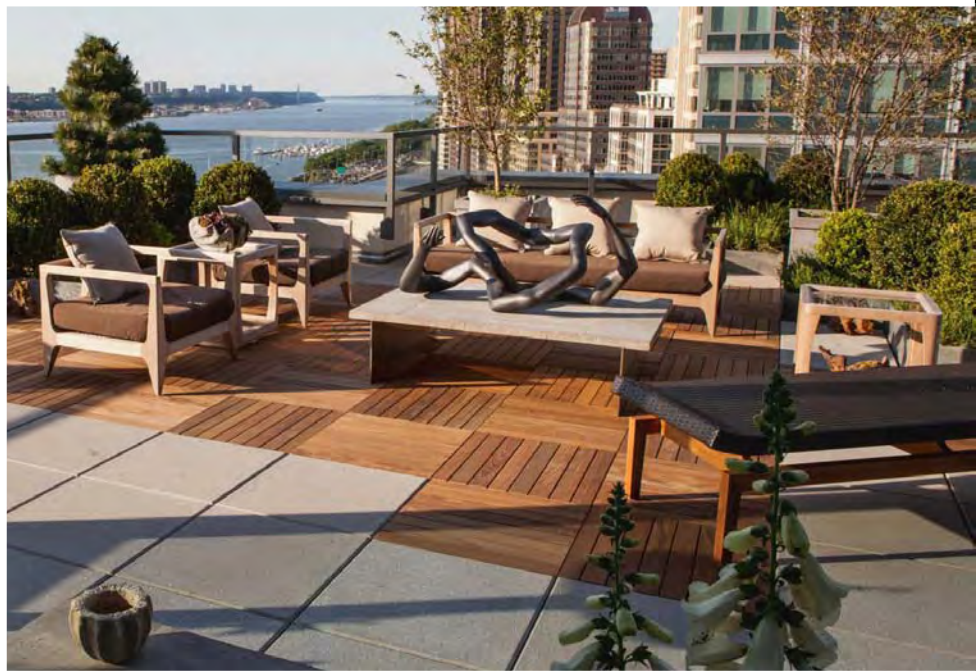

Applications

- Roof Decks
- Plaza Decks
- Pool Decks

..... 3



IPE Wood Tiles

- Details and Properties

..... 6

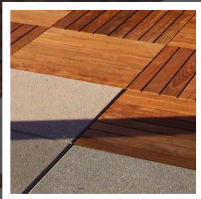

Material Comparison

- IPE
- Massaranduba
- Teak
- Pressure Treated Pine
- Composite Decking

..... 7



Adjustable Pedestals

- HYBRID Pedestal™ System
 - Uni-Just™
 - Stack-Cap™

..... 8



Installation Details

- IPE Deck Tiles over Pedestals
 - Single Ply
 - Hot Rubber
 - Modified Bitumen

..... 11



The concept of using IPÊ (EE-Pay) Wood Tiles as roof ballasts, plaza decks and terraces has created new opportunities for otherwise lost spaces. Roofs, decks and plazas can now be functional, as well as attractive. IPÊ Wood Tiles provide durability, protection and performance for the roof system from harsh weather conditions while providing drainage and a level walking surface. At only 6 lbs. per SqFt they are the ideal LIGHT WEIGHT choice as compared to other roof paving products.

Tile Tech offers a solution for all roofing & waterproofing needs from standard Walkway and Roof Ballast, to Architectural Plazas and Green Roofs. Functional design, color and durability all come together with Tile Tech roof and plaza Pavers and IPÊ Tiles.

As elegant in function as they are in appearance, Tile Tech IPÊ Tiles let you bring the natural beauty of exotic hardwood to any environment. They are an ideal solution for any indoor or outdoor areas, including patio, balconies, walkways, gardens, spa rooms and pool decks. Easy to install and able to stand the test of time, our innovative IPE tile and Pedestal systems can be

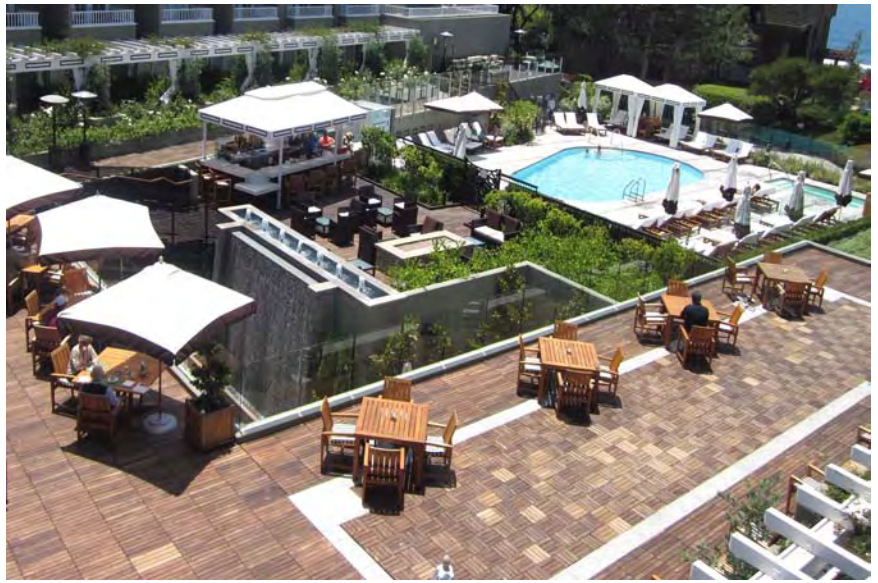

reconfigured, expanded and even taken with you when you move. Tile Tech IPÊ Wood Tiles is the original, leading brand of naturally durable wood tiles. Favored by design professionals and consumers alike, the Tile Tech IPE brand has become synonymous with commitment to superior quality and sustainable resources. Our product's strength, hardness and durability have been proven again and again in demanding residential and commercial applications.

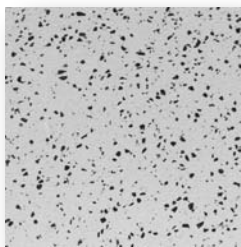

White Black Paver



Pedestal System

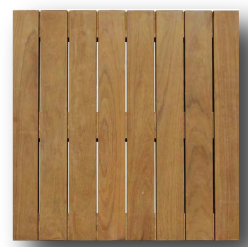

IPÊ Tile

By combining the natural beauty of IPE Wood Tiles with that of Architectural Pavers, the design possibilities are endless. Even after years of use, wood retains its beauty. If necessary, it can be easily renewed with another coat of finish or it can be entirely sanded and refinished. Because wood is a renewable resource, flooring constructed from it is an ecologically sound choice.

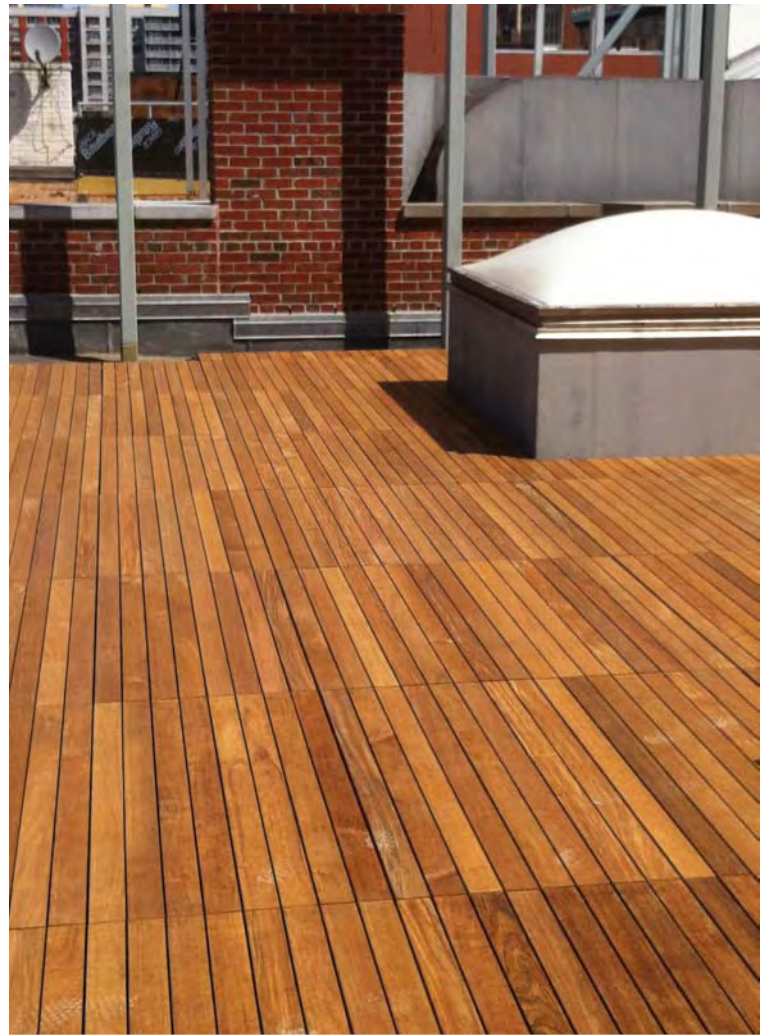
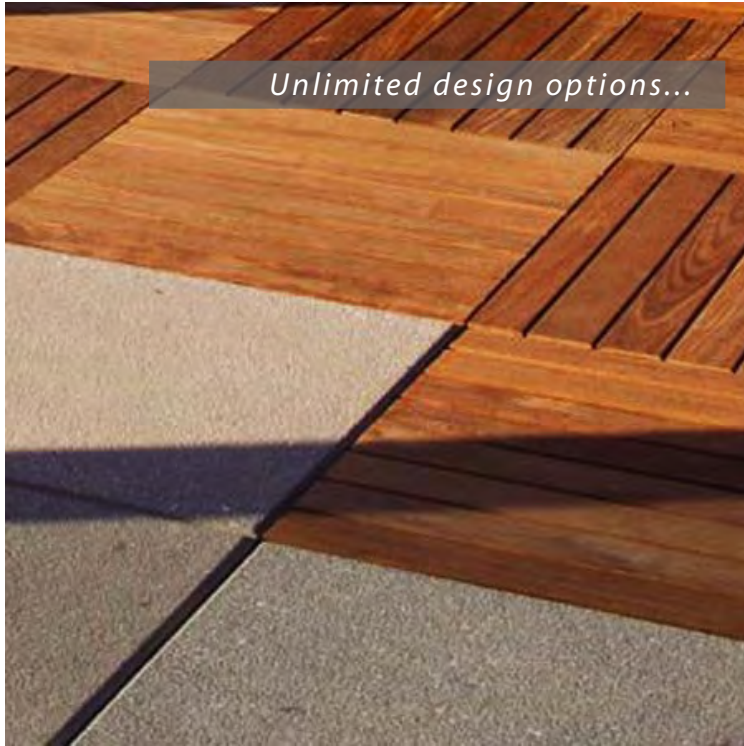

The application of an elevated paver system provides the designer with new possibilities and advantages. Tile Tech Pedestal System elevates, levels and uniformly spaces pavers thus allowing water to be channeled away from the surface. Roof and Plaza IPE Wood Tiles allow easy access to the roof and waterproofing system for making repairs or standard maintenance procedures effortless.

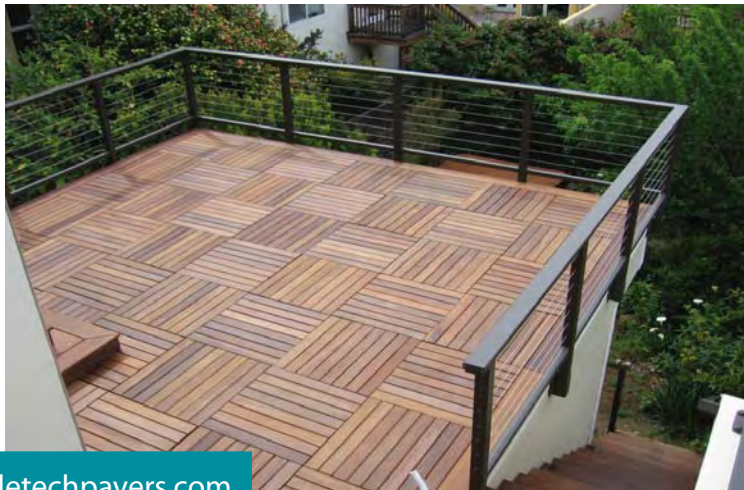

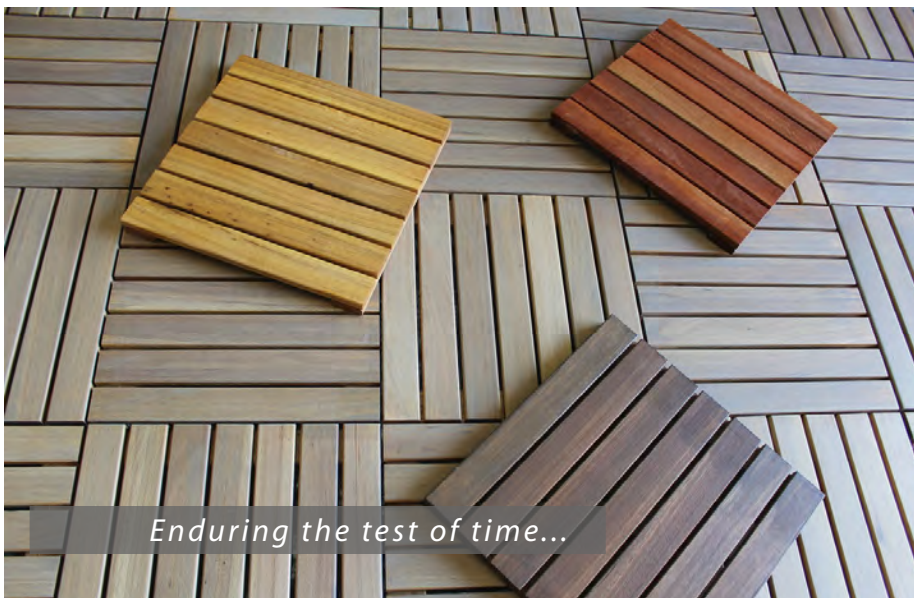

IPE Wood Tiles, also known as "Ironwood" are an incredibly durable Brazilian hardwood rated by the US Forest Lab for 25 years plus. Naturally resistant to fire, insects, moisture, and movement, this air dried hardwood (16-20%) is perfect for exterior commercial and residential applications such as roof decks, docks, or exterior plazas. In service for over 25 years from Atlantic City Boardwalk, to the Diner Key Marina in Miami, IPE has proven durability. It can be sealed and or stained to maintain its natural beauty or it can be allowed to weather to a beautiful silver gray.

When compared to other decking materials such as redwood, cedar, or copper chromium arsenate pressure treated materials, IPÊ gives longer life (3-5 times the life span), stronger resistance to fire, weather, insects and movement and is competitively priced with high grades of cedar and redwood. If you compare the one time cost of IPÊ to the 3-5 times you replace other materials over the life span of IPÊ, the value of IPÊ becomes very clear!



Patent Pending

TERMITE RESISTANCE - (15 years in ground without attack by termites) Highest Rating. **FIRE RESISTANCE** (ASTM-E84) tested to National Fire Protection Code, Class A, Uniform Building Code, Class 1; Highest Rating. **HARDNESS** (ASTM-D143) tested; Approximately seven times harder than Cedar, and can stand up to the harshest conditions imaginable. **SLIP RESISTANCE** (ASTM-C1028-89) tested; Our IPÊ deck tiles exceeds the ADA requirements for Static Coefficient of friction in a wet environment **STRENGTH** (ASTM-D143) tested; Three times stronger than Cedar, our IPÊ Decking tiles exceeds all existing code requirements for exterior constructions.

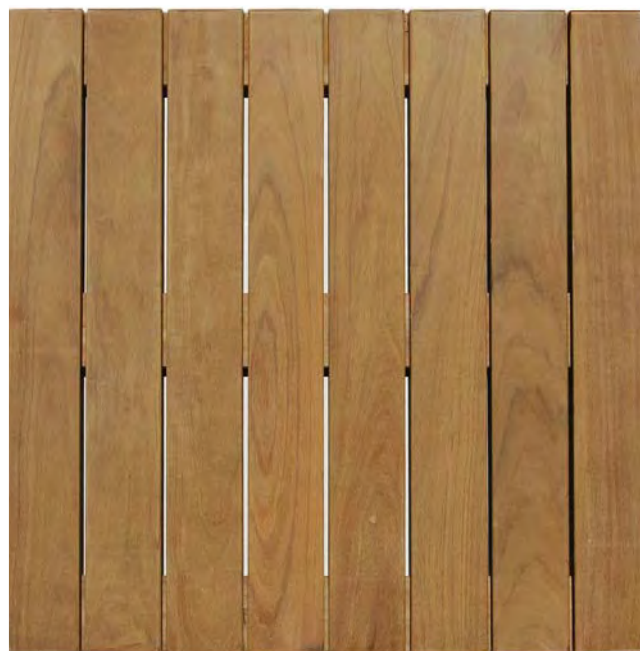
**DIMENSIONS:**

- 20" x 20" x 1-1/2"
- 24" x 24" x 1-5/8"
- 24" x 48" x 1-5/8" (Custom Size)

SURFACE:

- Smooth
- Grooved

WEIGHT:

- 5.75lbs per SqFt *LIGHT WEIGHT!*

FIRE RATING:

- Class A
(ASTM E108-07a Spread of Flame)

HARDNESS:

- 3,680 lbs (Janka Rating)

Tile Tech's IPE Wood paving tiles are designed for constructing raised wood decks over exterior surfaces such as rooftops, terraces and plazas, in both residential and commercial applications.

Our IPE Wood Tiles are constructed from kiln dried 1x3 IPE wood face slats secured to 3 IPE wood support runners (battens) using corrosion resistant stainless steel screws. Due to their high structural strength, dimensional stability and low flexing, Tile Tech's IPE paving tiles are specifically designed for installation on our pedestal supports, enabling decks with a perfectly horizontal surface to be built over sloping or irregular surfaces. Pedestals can be either fixed height or adjustable for slop compensation. The Pedestal System provide a broad footprint that can easily be installed and placed directly on top of roofing and waterproofing systems with no insulation.



Weathered

Waxed

Varnished



Smooth Surface Structural IPE Deck tiles is our most popular tile and exceeds the Americans with Disabilities Act requirements for Static Coefficient of friction in a wet environment (ASTM-C1028-89)



Grooved Surface Structural IPE Deck tiles provide the highest slip resistance for wet climates. often specified when added slip resistance is desired but not required.



Sealed or Weathered IPE Deck Tiles can be sealed to maintain its natural beauty or it can be allowed to weather to a beautiful silver gray. To retain the rich color, an oil based finish with ultraviolet inhibitors is recommended.



Structurally constructed with 7/8" thick boards for extra strength and resistance to flexing. A slot cut in the corner of each tile enables a special washer to be inserted and invisibly screwed to the top of the pedestal, thus locking down the tiles and ensuring a safe, secure and level surface.

WOOD TYPES	Hardness Janka Scale (lbs)	Bending Strength (psi)	Fire Rating	Decay Resistance	Life Span (years)	Appearance
IPÊ	3,680	22,560	High A	Highest rating for insect and termite resistance	30+	Also known as "Ironwood", is an extremely dense, tight grained. No splinters, surface stays smooth & resists damage.
Massaranduba	3,190	17,310	High A	Highest rating for insect and termite resistance.	25+	Also known as Brazilian Redwood, has a consistent reddish color with a fine straight grain and is nearly blemished free.
Teak	1,000	14,600	Medium B-C	Generally very resistant. Different grades will vary greatly	10-15	Very dense, straight-grained hardwood with a high natural oil content. Deep rich brown with some pieces displaying red and amber hues
Pressure Treated Pine	870	14,500	Varies	Chromated copper arsenate in wood offers excellent resistance, but with potential health and environmental risks.	10	Surface develops splits, checks, boards cup and twist, becomes rough & gray to green without regular sealing
Composite Decking	940 - 1,390	1,500 - 4,500	Low C-D	Generally resistant. Different types will vary greatly	10-15	Tendency to sag, expand, contract and fade in sunlight. Susceptible to moisture, mold and mildew
Redwood	480	7,900	Low C-D	Resistant to decay, but relatively soft and quick to weather.	10-12	Usually straight grained with a fine, even texture. Scratches easily, splinters & becomes black gray without regular sealing.

The **Janka hardness** is a measurement of the force necessary to embed a .444-inch steel ball to half its diameter in wood, and is the industry standard for gauging a wood product's resistance to wear and denting.

Top View



Bottom View

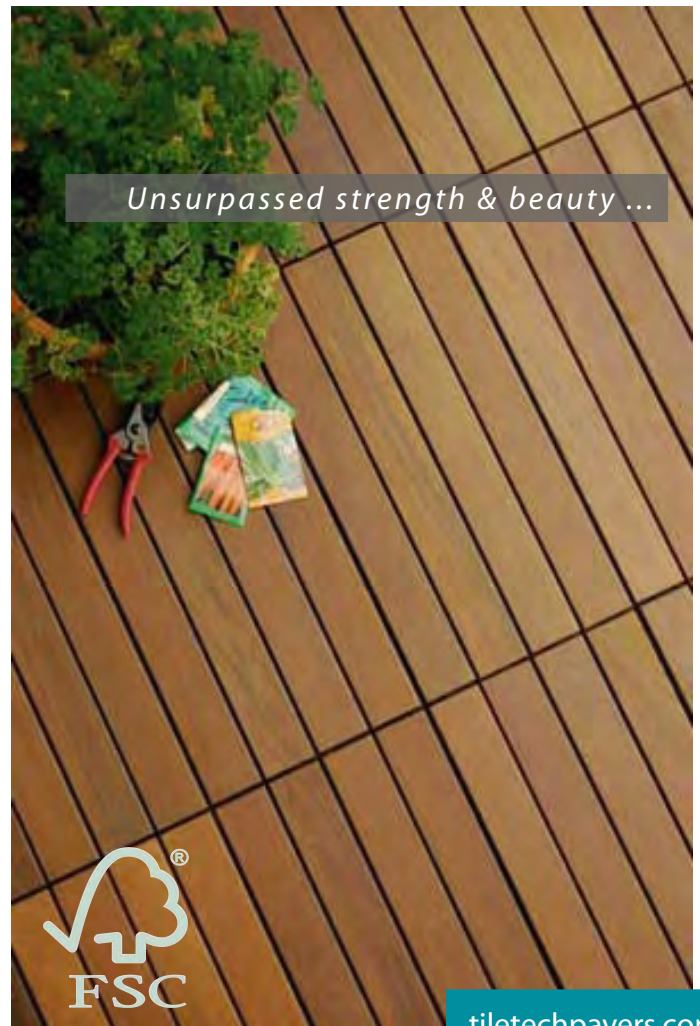

H Y B R I D

Adjustable Pedestal System

New

PATENT
filed for
international
patent
PENDING



Pat. # 8,453,391 & Pat. Pen

The Tile Tech Pedestal System is designed for concrete pavers or IPE Wood Tiles to lay level over a built up roof. The substrate can be either concrete or wood structure, with a roof membrane over the top.

Our new Hybrid Pedestal™ System consists of 7 standard components and off-the-shelf, 4.215" diameter SDR-35 PVC pipe. The PVC pipe allows the pedestal system to vary in height up to 22+ inches and is cut to the desired height using 12" chop saw. The Uni-Base is then "press fit" on to one end of the PVC pipe and a Uni-Collar on to the other end and require no gluing or other attachments. Either 3/4" or 1-1/2" Uni-Insert is then screwed in to the Uni-Collar allowing for fine height adjustments. The assembly is completed by aligning and locking the Uni-Cap with the Uni-Insert. The Uni-Cap features include built-in self-leveling and removable 1/8" spacer tabs for proper paver spacing and joint alignment.



Stackable caps allow for minor height adjustments from 1/2" up to 6" and can compensate for slopes of 0% to 3% by aligning the built-in slope compensator of one cap relative to another. *Simple, easy and affordable!*



Single model design allows for all height applications from low as 1/2" and as high as 22" resulting in reduced labor and material cost.

Eliminates leftover parts and pieces!







PVC pipe adjustment allows the pedestal system to vary in heights up to 22+ inches by using off-the-shelf 4"Ø SDR-35 PVC pipe available everywhere. *Eliminates material & shipping cost!*



Screw adjustment allows for quick and easy fine height tuning for an additional 3/4" or 1-1/2" depending on model size of UNI-INSERT™ used. *Eliminates having to cut pipe exactly!*

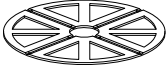
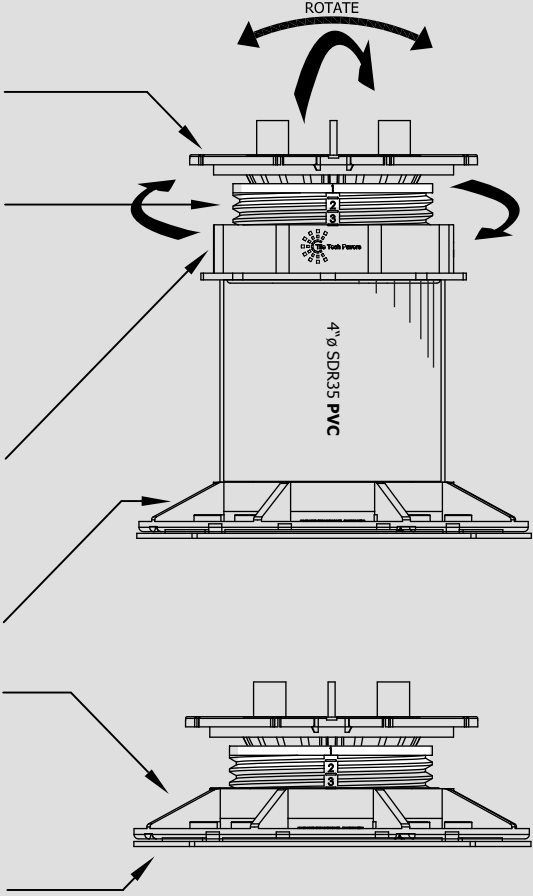

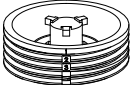
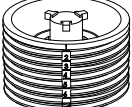
Self-Leveling head allows for slope compensation of 0% to 6% in any direction. Allen or Hex key will allow for leveling while loaded with pavers. *Eliminates having to remove pavers to make adjustments!*

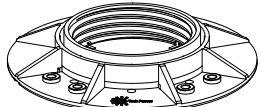
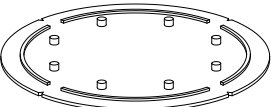
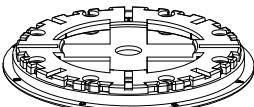
PEDESTAL DETAILS	Component	Function	Assembly Diagram
	UNI-SHIM™ 1/8" & 1/16"	Allow for fine tuning of individual pavers. Can be broken in to quarters or halves and stacked on top or bottom of pedestals.	 <p data-bbox="1103 1331 1521 1444">4"Ø SDR-35 PVC pipe is user supplied & cut to required height. All pedestal systems can be used with or without PVC pipe depending on height.</p>
	UNI-CAP™	Align and lock on to UNI-INSERT and allows for self-leveling in any direction from 0% to 6% slope.	
	UNI-INSERT™ 3/4"	Screw in to UNI-COLLAR and allows for additional height adjustment of either 3/4".	
	UNI-INSERT™ 1-1/2"	Screw in to UNI-COLLAR and allows for additional height adjustment of 1-1/2".	
	UNI-COLLAR™	Compression fits on to end of 4"Ø SDR-35 PVC pipe and allowing UNI-INSERT to screw in to the system.	
	UNI-BASE™	Compression fits on to end of 4"Ø SDR35 PVC pipe or can be used with UNI-INSERT alone.	
	BUFFER PAD™ (Mandatory)	Used under base to provide slip resistance, noise dampening & membrane protection.	
	STACK-CAPS™	Used of low height requirements. Rotate and stack caps for slope & height adjustment. Can also be used with PVC pipe to reach 6" max.	

PEDESTAL PROPERTIES	TEST METHOD	RESULTS
Tensile Strength	ASTM C-638	6,300psi Minimum
Flexural Modulus	ASTM C-790	35,000psi Minimum
Flexural Strength	ASTM C-790	10,500psi Minimum
Softening Point	ASTM C-1525	226° F
Freeze Thaw	ASTM C-	Unaffected
Material	HDPP - High Density Polypropylene * Resistant to oils, acids, alkalis, bitumen, mold and algae.	



For complete material & installation specifications, please visit our website or contact us.



1. In a typical installation do not start first row of pavers at perimeter wall, instead begin installation of full pavers at the second row in the roof field.
2. Mark perpendicular guidelines on substrate surface to ensure square layout.
3. The first height of the pedestal is then determined and PVC pipe is cut with a standard 12" shop saw to the required height, less 3/8" for bottom base and collar insets plus buffer pad. The Uni-Insert will provide an additional 3/4" or 1-1/2" of height depending on the model size used.
4. Install initial pavers along guidelines forming a "T" pattern. Install remaining field pavers out from "T".
5. Perimeter pavers are installed last and normally cut and less than full size to ensure proper layout and fit. Pedestal spacer tabs can be removed in order to position pedestals at perimeter just tangent to wall.
6. Any section of the roof that receives concrete pavers that is not restrained by an abutting wall or parapet must be "boxed in" by some field installed restraint. No movement should be allowed at the perimeter of a paver system.

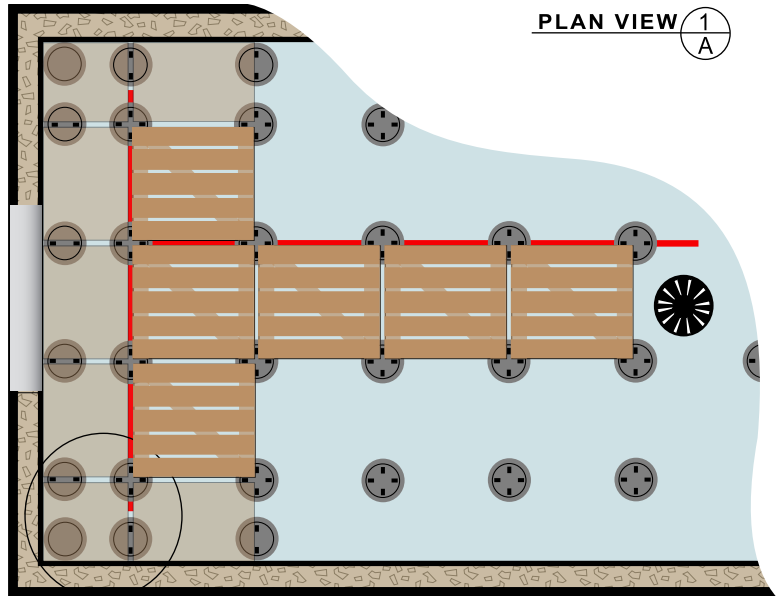

A step above the rest...

Quick water drainage. The gap between and under Tile Tech IPE Tiles™ allows for rapid water discharge on to substrate surface.

Concealment of utilities, pipes and drains. The void between the IPÊ Tile and membrane can be used to accommodate pipes and services including drains, but retain easy access for maintenance and repair.

Thermal insulation & protection. The void between the paving and membrane encourages constant air circulation, extending the life of the waterproofing and improving heat insulation in addition to protecting the substrate surface from UV degradation.

Level paving & significant less weight. With no requirement for special surface preparations, such as sand or aggregate bedding the floating system provides a level, light weight solution, allowing structures to be built with less loading on structure and at substantially lower cost.

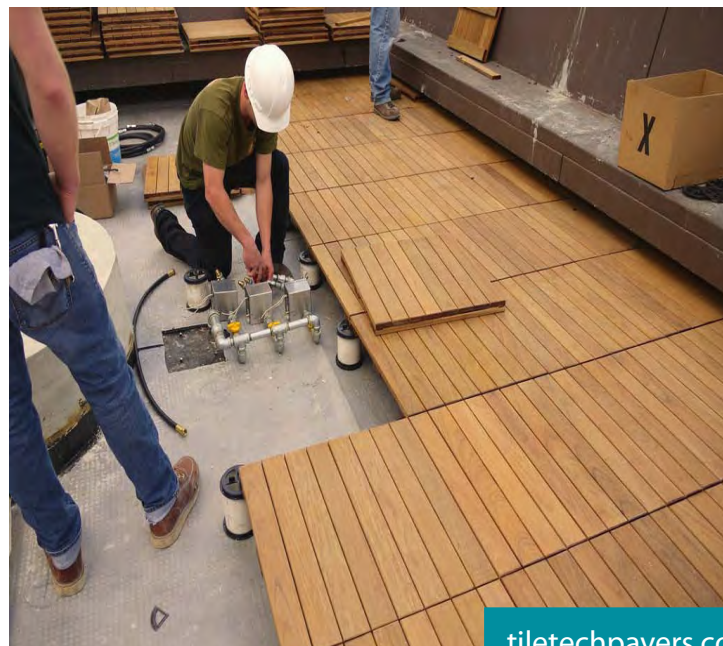
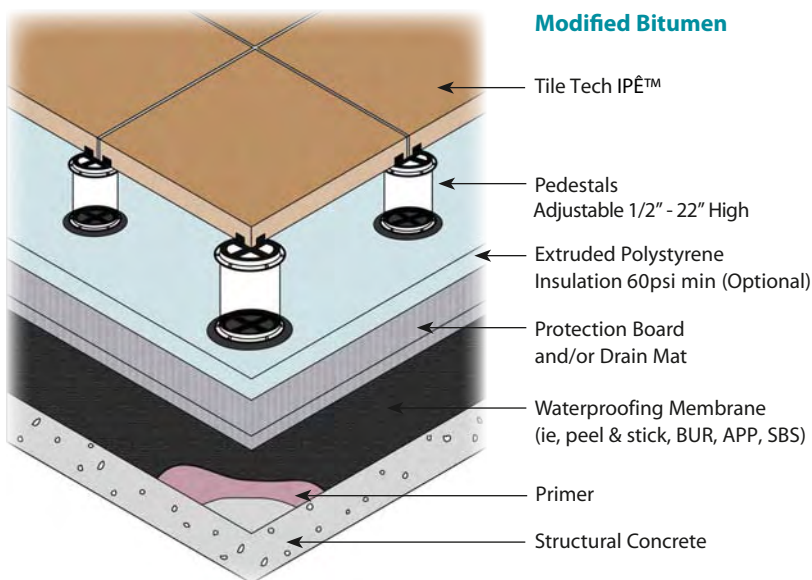
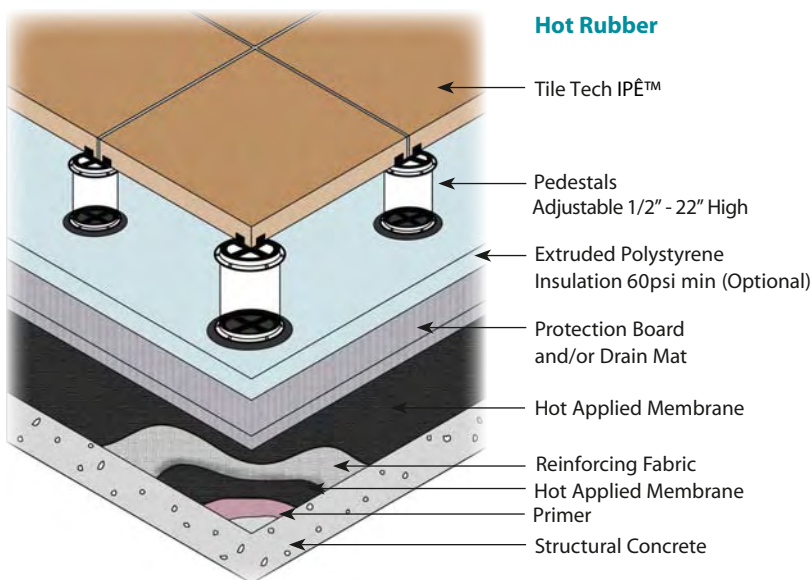
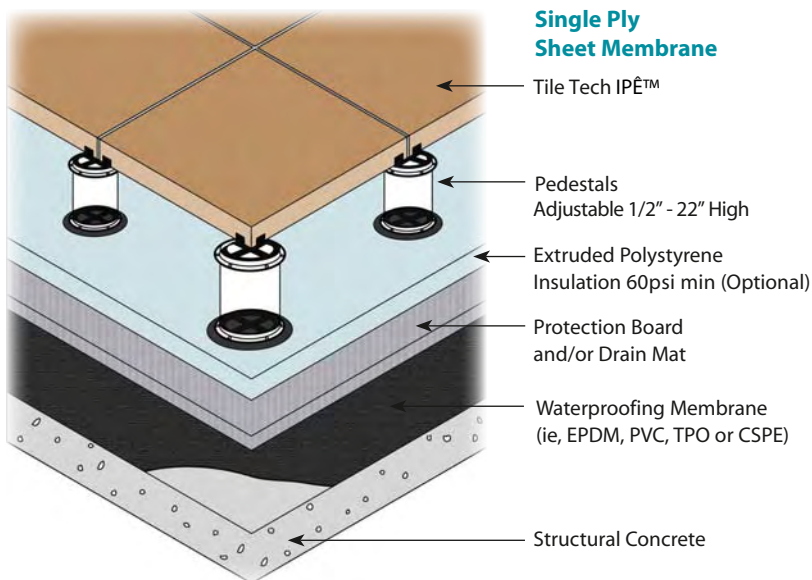

PART ONE- GENERAL

1.2 SUMMARY

- A. Scope of work
 - 1. IPE Wood Tiles
 - 2. Adjustable Pedestals

1.4 SUBMITTALS

- A. Product Data Sheet
 - 1. Including preparation instructions, installation methods, storage and handling requirements.
- B. Samples
 - 1. Submit two sets of standard color chips of manufacturer's full range.

1.5 QUALITY ASSURANCE

- A. Manufacturer
 - 1. Minimum of 5 years experience manufacturing precast pavers.
 - 2. Supply a written installation procedure manual.
- B. Installation Contractor
 - 1. Minimum of 1 year experience installing precast pavers on projects of similar size.
 - 2. Installation contractor must meet all local & state licensing & bonding requirements.

1.8 WARRANTY

- A. Manufacturer
 - 1. Shall warrant installed pavers for a period of 5 year from date of substantial completion against failure of materials.
- B. Installation Contractor
 - 1. Shall warrant installed pavers for a period of 3 year from date of substantial completion against failure of workmanship.

PART TWO - PRODUCTS

2.1 MANUFACTURER

- A. Tile Tech Pavers Inc.
 - Tel.....213-380-5560
 - Fax.....213-380-5561
 - Toll Free.....888-380-5575
 - Web.....tiletechpavers.com

2.2 MATERIALS

- A. IPE Wood Tiles
 - 1. Size: 20" x 20" x 1-1/2"
24" x 24" x 1-7/8"
24" x 48" x 1-7/8 (Custom)
 - 2. Finish: Smooth Surface
Grooved Surface

SELECT ONE SYSTEM BELLOW OR COMBINE

- B. Uni-Just Pedestal System
 - 1. Uni-Base
 - 2. Uni-Cap
 - 3. Uni-Collar
 - 4. Uni-Insert: Model 3/4" or 1-1/2"
 - 5. Uni-Shim: Model 1/16" and 1/8"
 - 6. Uni-Spacer
 - 7. Uni-Buffer Pad
 - 8. SDR-35 PVC Pipe (4.215" OD)
User supplied and cut to desired height.
- C. Stack-Cap Pedestal System
 - 1. Stack-Cap
 - 2. Uni-Shim: Model 1/16" and 1/8"
 - 3. Uni-Spacer
 - 4. Uni-Buffer Pad
 - 5. SDR-35 PVC Pipe (4.215" OD)
User supplied and cut to desired height.

PART THREE - EXECUTION

3.1 EXAMINATION

- A. Examine area to receive IPE & Pedestal system and verify:
- B. Substrate surface are smooth, sound, clean and free of irregularities.
- C. Related work penetrating the plane of roof is completed.
- D. Verify that the roof deck will sustain the weight of the IPE Tile System.
- E. Do not commence IPE Tile application until unsatisfactory conditions are satisfied.

3.2 PREPARATION

- A. Broom deck surface clean.

3.3 INSTALLATION

- A. Install in accordance with Tile Tech Pavers and other contributing manufacturer's instructions.
- B. First, determine a starting point; this will be largely dependent on where less than full size IPE Tile are to be used.
- C. Establish a grid pattern for the pedestals using chalk lines.
- D. Use a laser leveling device or a mason's line to determine finished elevation of the deck surface and height of PVC Pipe to be cut. Assemble Adjustable Pedestal System components and place at grid line intersections.
- E. Install Tile Tech IPE Wood Tiles on top of pedestals. Fine tune adjustments to the tile surface can be made by using the pedestal shims.
- F. Once level, Insert special washer in to the slot in the corner of 3 tiles than install 4th tile. Screw down the washer locking down the 4 tile corners and ensuring a safe, secure and level surface.

For complete material & installation specifications, please contact Tile Tech Pavers



 888-380-5575

 213-380-5561

 Sales@tiletechpavers.com

 www.TileTechPavers.com